

---

Designed & Engineered in Italy

# STREET LIGHT PA

grid

E004

---

# CONTENT

## STREET LIGHT PA

### GRID Type

- **ALESSANDRIA Series**
  - SLA0 048 ALO 001
  - SLA0 048 ALO 002
  - SLA0 048 ALO 003
  - SLA0 048 ALO 004



AC power

# STREET LIGHT PA - 19W

## ALESSANDRIA Series

### SLA0 048 ALO 001



| MAIN FEATURES                 |  | SLA0 048 ALO 001                        |
|-------------------------------|--|-----------------------------------------|
| Product description           |  | Led street light                        |
| Model                         |  | SLA0 048 ALO 001                        |
| Peak Power                    |  | 19W                                     |
| ELECTRICAL PARAMETERS         |  | SLA0 048 ALO 001                        |
| Led Driver                    |  | Inventronics EUM - 050S090DG            |
| Working Voltage               |  | AC 100-277V                             |
| Frequency                     |  | 50/60Hz                                 |
| Power Factor                  |  | ≥0.92C                                  |
| Efficiency                    |  | >0.92                                   |
| Dimming Function(VN)          |  | 5 steps Dimming (Virtual night setting) |
| Driver Surge Protection*      |  | 6KV (grounded)                          |
| Surge Protection Device       |  | Umax. 20KV                              |
| Twilight Function             |  | Available                               |
| Driver IP ranking             |  | IP67                                    |
| PHYSICAL PARAMETERS           |  | SLA0 048 ALO 001                        |
| Housing material              |  | Die-casting aluminium                   |
| Surface treatment             |  | Powder coating                          |
| Product color                 |  | Customization available                 |
| Product size - Product weight |  | 550x200x105mm - 3.2kg                   |
| Mounting stem                 |  | 60mm                                    |
| IP rating                     |  | IP65                                    |
| IK rating                     |  | IK08                                    |

# STREET LIGHT PA - 19W

## ALESSANDRIA Series

### SLA0 048 AL0 001

| OPTICAL PARAMETERS    | SLA0 048 AL0 001                         |
|-----------------------|------------------------------------------|
| Light Source          | LED                                      |
| Module qty            | 6                                        |
| Led brand             | LUMILEDS                                 |
| Led model             | LUXEON 5050                              |
| Led chip qty          | 48                                       |
| Luminous flux         | 3041.8lm                                 |
| Luminous efficiency   | 161.28lm/w                               |
| Beam angle            | 144.8, 89.6                              |
| Lens                  | DK-5050-146X83-TP-III-S-8HI-LUMILEDS5050 |
| Light distribution    | TYPE II-S                                |
| Color temperature     | 4000K                                    |
| Color rendering index | >75                                      |

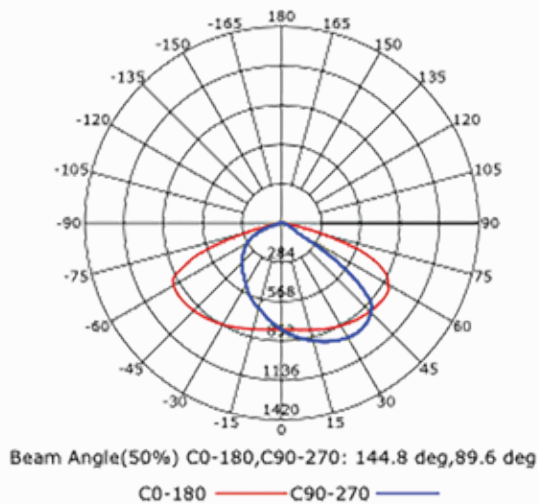

Luminous Intensity Distribution Curve

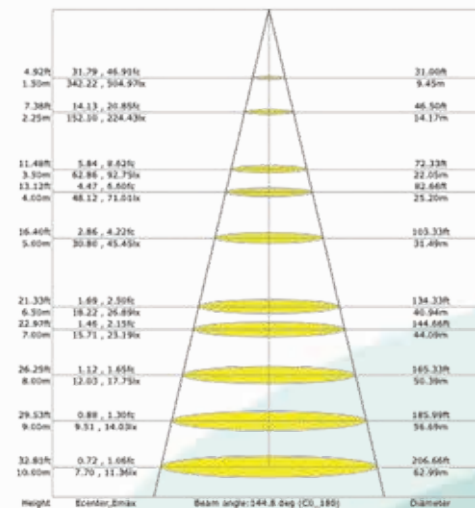

LX-Distance Diagram

| PACKING INFO    | SLA0 048 AL0 001 |
|-----------------|------------------|
| Packing method  | Carton           |
| Carton capacity | 1 pc/ctn         |
| WARRANTY        | SLA0 048 AL0 001 |
| Years           | 5                |





AC power

# STREET LIGHT PA - 41W

## ALESSANDRIA Series

### SLA0 048 AL0 002



| MAIN FEATURES                 |  | SLA0 048 AL0 002                        |
|-------------------------------|--|-----------------------------------------|
| Product description           |  | Led street light                        |
| Model                         |  | SLA0 048 AL0 002                        |
| Peak Power                    |  | 41W                                     |
| ELECTRICAL PARAMETERS         |  | SLA0 048 AL0 002                        |
| LED Driver                    |  | Inventronics EUM - 050S090DG            |
| Working Voltage               |  | AC100-277V                              |
| Frequency                     |  | 50/60Hz                                 |
| Power Factor                  |  | ≥0.92C                                  |
| Efficiency                    |  | >0.92                                   |
| Dimming Function(VN)          |  | 5 steps Dimming (Virtual Night setting) |
| Driver Surge Protection*      |  | 6KV (grounded)                          |
| Surge Protection Device       |  | Umax. 20KV                              |
| Twilight Function             |  | Available                               |
| Driver IP ranking             |  | IP67                                    |
| PHYSICAL PARAMETERS           |  | SLA0 048 AL0 002                        |
| Housing material              |  | Die-casting aluminium                   |
| Surface treatment             |  | Powder coating                          |
| Product color                 |  | Customization available                 |
| Product size - Product weight |  | 615x233x100mm - 4.1kg                   |
| Mounting stem                 |  | 60mm                                    |
| IP rating                     |  | IP65                                    |
| IK rating                     |  | IK08                                    |

# STREET LIGHT PA - 41W

## ALESSANDRIA Series

### SLA0 048 ALO 002

| OPTICAL PARAMETERS    | SLA0 048 ALO 002                         |
|-----------------------|------------------------------------------|
| Light Source          | LED                                      |
| Module Qty            | 9                                        |
| LED brand             | LUMILEDS                                 |
| LED model             | LUXEON 5050                              |
| LED chip qty          | 72                                       |
| Luminous flux         | 6797.025lm                               |
| Luminous efficiency   | 165.90lm/w                               |
| Beam angle            | 146.2, 91                                |
| Lens                  | DK-5050-146X83-TP-III-S-8HI-LUMILEDS5050 |
| Light distribution    | TYPE II-S                                |
| Color temperature     | 4000K                                    |
| Color rendering index | >75                                      |

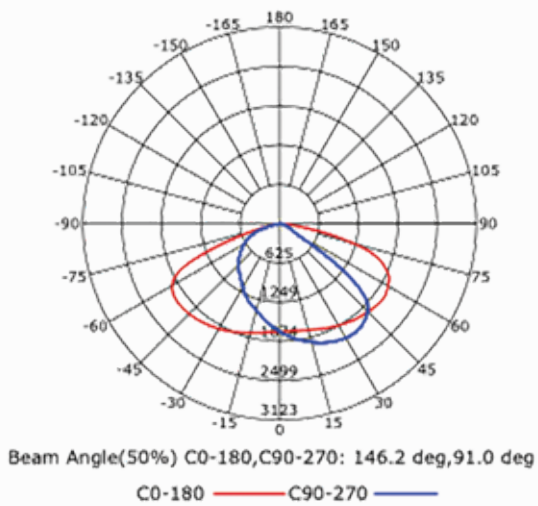

Luminous Intensity Distribution Curve

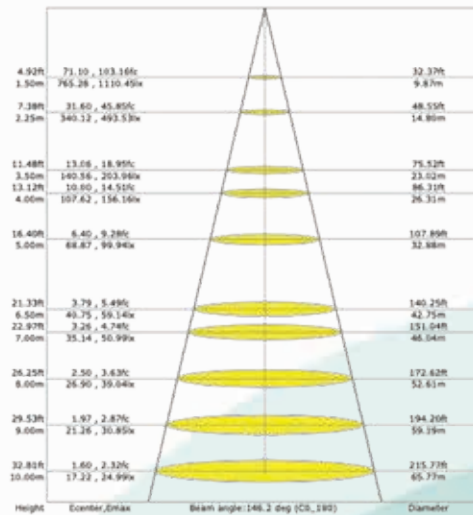

LX-Distance Diagram

| PACKING INFO    | SLA0 048 ALO 002 |
|-----------------|------------------|
| Packing method  | Carton           |
| Carton capacity | 1 pc/ctn         |
| WARRANTY        | SLA0 048 ALO 002 |
| Years           | 5                |



AC power

# STREET LIGHT PA - 41W

## ALESSANDRIA Series

### SLA0 048 ALO 002

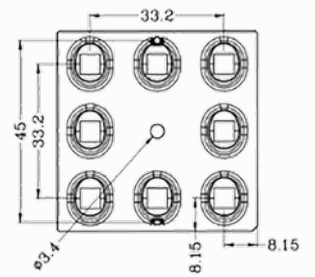
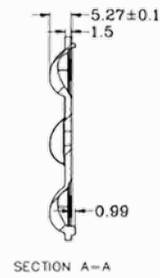
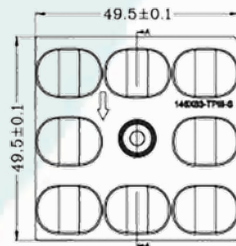

SPD  
(optional)

Driver

100



615

233

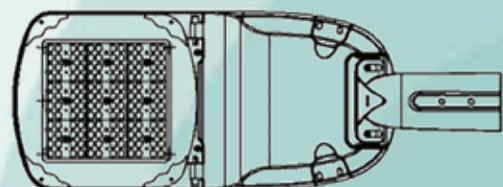



AC power

**STREET LIGHT PA**  
**ALESSANDRIA Series**  
**SLA0 048 ALO 001 / SLA0 048 ALO 002**





AC power

# STREET LIGHT PA - 54W

## ALESSANDRIA Series

### SLA0 048 AL0 003



| MAIN FEATURES                 | SLA0 048 AL0 003                        |
|-------------------------------|-----------------------------------------|
| Product description           | Led street light                        |
| Model                         | SLA0 048 AL0 003                        |
| Peak Power                    | 54W                                     |
| ELECTRICAL PARAMETERS         | SLA0 048 AL0 003                        |
| LED Driver                    | Inventronics EUM - 050S090DG            |
| Working Voltage               | AC100-277V                              |
| Frequency                     | 50/60Hz                                 |
| Power Factor                  | ≥0.92C                                  |
| Efficiency                    | >0.92                                   |
| Dimming Function(VN)          | 5 steps Dimming (Virtual night setting) |
| Driver Surge Protection*      | 10KV (grounded)                         |
| Surge Protection Device       | Umax. 20KV                              |
| Twilight Function             | Available                               |
| Driver IP ranking             | IP67                                    |
| PHYSICAL PARAMETERS           | SLA0 048 AL0 003                        |
| Housing material              | Die-casting aluminium                   |
| Surface treatment             | Powder coating                          |
| Product color                 | Customization available                 |
| Product size - Product weight | 615x233x100mm - 4.1kg                   |
| Mounting stem                 | 60mm                                    |
| IP rating                     | IP65                                    |
| IK rating                     | IK08                                    |

# STREET LIGHT PA - 54W

## ALESSANDRIA Series

### SLA0 048 ALO 003

| OPTICAL PARAMETERS    | SLA0 048 ALO 003                         |
|-----------------------|------------------------------------------|
| Light Source          | LED                                      |
| Module Qty            | 9                                        |
| LED Brand             | LUMILEDS                                 |
| LED model             | LUXEON 5050                              |
| LED chip qty          | 72                                       |
| Luminous flux         | 8981.067lm                               |
| Luminous efficiency   | 164.76lm/w                               |
| Beam angle            | 145.9, 89.2                              |
| Lens                  | DK-5050-146X83-TP-III-S-8HI-LUMILEDS5050 |
| Light distribution    | TYPE II-S                                |
| Color temperature     | 4000K                                    |
| Color rendering index | >75                                      |

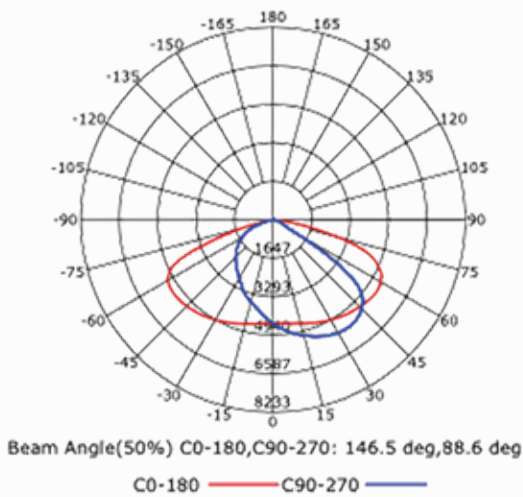

Luminous Intensity Distribution Curve

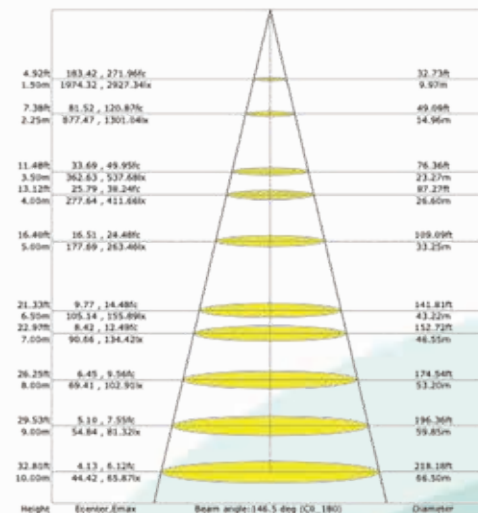

LX-Distance Diagram

| PACKING INFO    | SLA0 048 ALO 003 |
|-----------------|------------------|
| Packing method  | Carton           |
| Carton capacity | 1 pc/ctn         |
| WARRANTY        | SLA0 048 ALO 003 |
| Years           | 5                |



AC power

# STREET LIGHT PA - 54W

## ALESSANDRIA Series

### SLA0 048 ALO 003

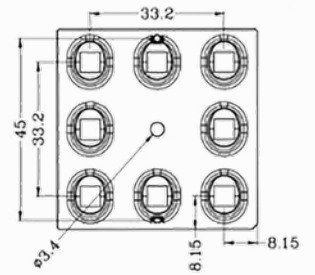
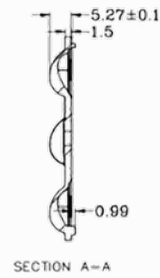
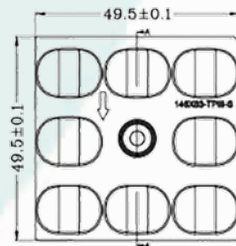

SPD  
(optional)

Driver

100



615

233



# STREET LIGHT PA - 106W

## ALESSANDRIA Series

### SLA0 048 AL0 004



| MAIN FEATURES                 |  | SLA0 048 AL0 004                        |
|-------------------------------|--|-----------------------------------------|
| Product description           |  | Led street light                        |
| Model                         |  | SLA0 048 AL0 004                        |
| Peak Power                    |  | 106W                                    |
| ELECTRICAL PARAMETERS         |  | SLA0 048 AL0 004                        |
| LED Driver                    |  | Inventronics EUM - 050S090DG            |
| Working Voltage               |  | AC100-277V                              |
| Frequency                     |  | 50/60Hz                                 |
| Power Factor                  |  | ≥0.92C                                  |
| Efficiency                    |  | >0.92                                   |
| Dimming Function(VN)          |  | 5 steps Dimming (Virtual night setting) |
| Driver Surge Protection*      |  | 10KV (grounded)                         |
| Surge Protection Device       |  | Umax. 20KV                              |
| Twilight Function             |  | Available                               |
| Driver IP ranking             |  | IP67                                    |
| PHYSICAL PARAMETERS           |  | SLA0 048 AL0 004                        |
| Housing material              |  | Die-casting aluminium                   |
| Surface treatment             |  | Powder coating                          |
| Product color                 |  | Customization available                 |
| Product size - Product weight |  | 675x260x100mm - 4.8kg                   |
| Mounting stem                 |  | 60mm                                    |
| IP rating                     |  | IP65                                    |
| IK rating                     |  | IK08                                    |

# STREET LIGHT PA - 106W

## ALESSANDRIA Series

### SLA0 048 ALO 004

| OPTICAL PARAMETERS    | SLA0 048 ALO 004                         |
|-----------------------|------------------------------------------|
| Light Source          | LED                                      |
| Module Qty            | 9                                        |
| LED Brand             | LUMILEDS                                 |
| LED model             | LUXEON 5050                              |
| LED chip qty          | 96                                       |
| Luminous flux         | 18006.62lm                               |
| Luminous efficiency   | 170.08lm/w                               |
| Beam angle            | 146.5, 88.6                              |
| Lens                  | DK-5050-146X83-TP-III-S-8HI-LUMILEDS5050 |
| Light distribution    | TYPE II-S                                |
| Color temperature     | 4000K                                    |
| Color rendering index | >75                                      |

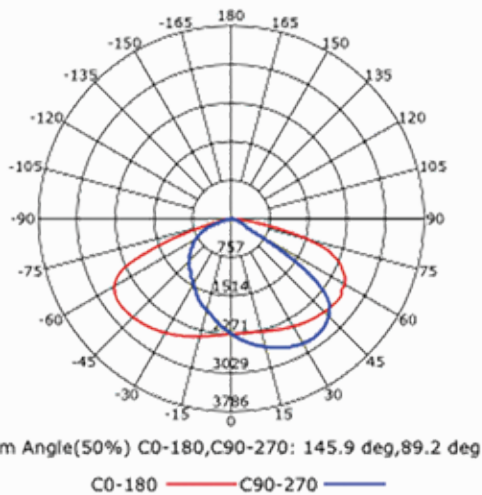

Luminous Intensity Distribution Curve

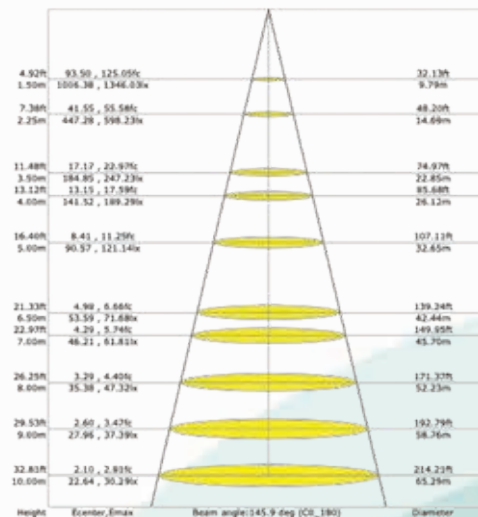

LX-Distance Diagram

| PACKING INFO    | SLA0 048 ALO 004 |
|-----------------|------------------|
| Packing method  | Carton           |
| Carton capacity | 1 pc/ctn         |
| WARRANTY        | SLA0 048 ALO 004 |
| Years           | 5                |

**STREET LIGHT PA - 106W**  
**ALESSANDRIA Series**  
**SLA0 048 ALO 004**

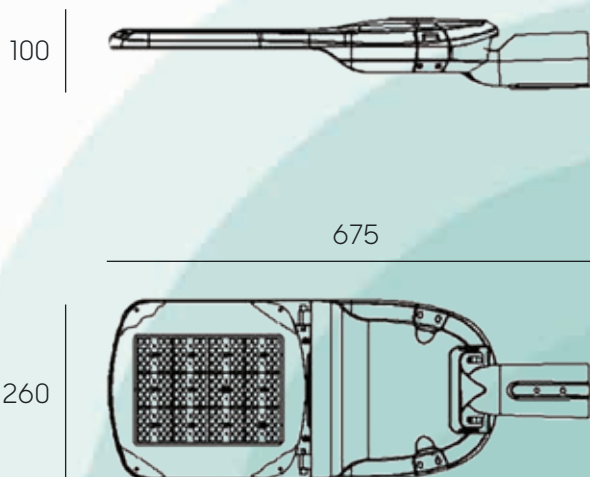
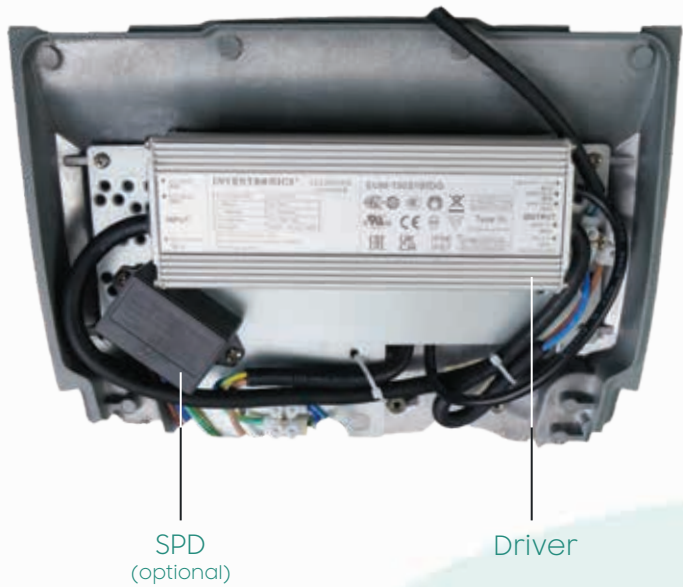
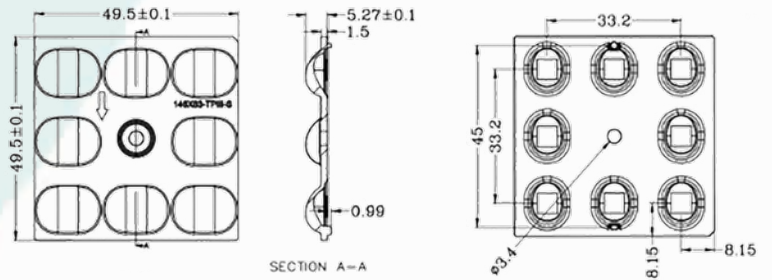



AC power

**STREET LIGHT PA**  
**ALESSANDRIA Series**  
**SLA0 048 ALO 003 / SLA0 048 ALO 004**





[www.enetra.it](http://www.enetra.it)



ARISON Italia srl  
Via Santissima Trinità 3 - 41121 Modena - Italy  
[info@arisonitalia.com](mailto:info@arisonitalia.com)